

FEATURES

- 50Ω & 100Ω IMPEDANCE OPTIONS
- EXCELLENT AMPLITUDE & PHASE BALANCE
- 0402, 0603 & 0805 CASE SIZES
- INTERNAL SHIELDING
- SMALL SIZE & LOW PROFILE LTCC CONSTRUCTION
- TAPED AND REELED FOR AUTOMATIC INSERTION

**RoHS
Compliant**

includes all homogeneous materials

*See Part Number System for Details

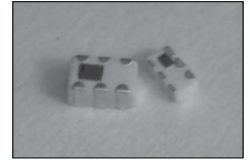

CHARACTERISTICS

Case Code	NGB0402C	NGB0603C	NGB0805C
Center Frequency Ranges	2450 MHz	2450 MHz ~ 5400 MHz	2400 MHz
Operating Temperature Range	-40°C ~ +85°C		
Balanced Port Impedance	50Ω		
Unbalanced Port Impedances	50Ω	50Ω, 100Ω	
Resistance to Solder Heat	+260°C for 10 seconds		

PART NUMBER SYSTEM

NGB 0805CG 2R400G 050 TR F

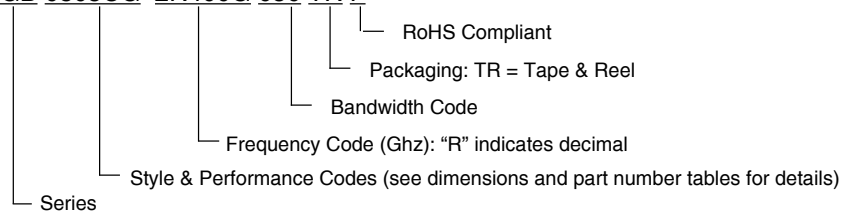

0402 DIMENSIONS (mm)

Case Code	DIMENSIONS								LAND PATTERNS			
	A	B	C	D	E	F	G	H	W	X	Y	Z
NGB0402C	1.0 ± 0.05	0.50 ± 0.05	0.40 max.	0.14 ± 0.05	0.30 ± 0.05	0.50 ± 0.10	0.30 ± 0.10	0.20 ± 0.10	0.20	0.25	0.40	0.60

0402 COMPONENT LAYOUT (in mm)

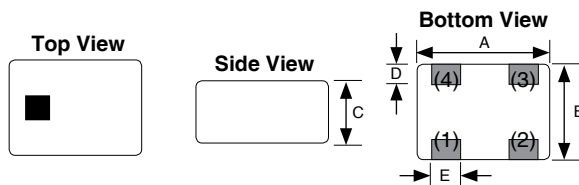

0402 LAND PATTERNS (in mm)

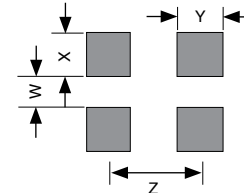

Pin Configuration	(1)	(2)	(3)	(4)
0402	Unbalanced	Balanced	Balanced	Ground

NGB0402C ELECTRICAL CHARACTERISTICS

Part Number	Standard Values - Case Size 0402 (1.0 x 0.5 mm)							
	Port Impedance		Center Frequency (MHz)	Insertion Loss.	Balance Port VSWR	Amplitude Difference (dB)	Phase Difference (Deg.)	Power Capacity (mW)
	Unbalanced	Balanced						
NGB0402CG2R450G050TRF	50Ω	50Ω	2450 ± 100	1.0 Max. at 25°C 1.1 Max. at -40 to +85°C	1.6 Max.	1.5 Max.	180° ± 10°	500mW

(Customization Available. Please contact NIC for any center frequency and chipset matching requirements)



0603 & 0805 DIMENSIONS (mm)

Case Code	DIMENSIONS								LAND PATTERNS			
	A	B	C	D	E	F	G	H	W	X	Y	Z
NGB0603C	1.60 ± 0.10	0.80 ± 0.10	0.60 ± 0.10	0.15 ± 0.10	0.20 ± 0.10	0.50 ± 0.10	0.30 ± 0.10	0.20 ± 0.10	0.30	0.55	0.25	0.50
NGB0805C	2.00 ± 0.15	1.20 ± 0.15	0.95 ± 0.10	0.20 ± 0.10	0.30 ± 0.15	0.65 ± 0.10	-	0.20 ± 0.10	0.75	0.50	0.35	0.65

0603 & 0805 COMPONENT LAYOUT (in mm)

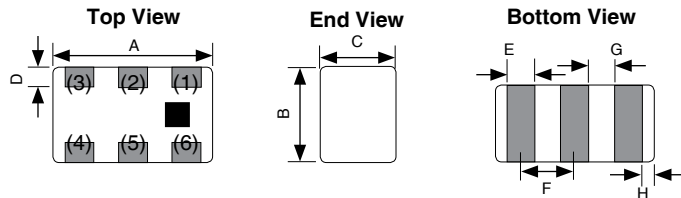

0603 & 0805 LAND PATTERNS (in mm)

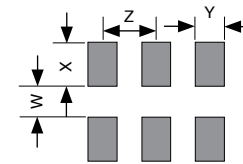

Pin Configuration	(1)	(2)	(3)	(4)	(5)	(6)
0603 & 0805	Unbalanced	Ground (DC Feed & RF Ground)	Balanced	Balanced	Ground	NC

NGB0603C ELECTRICAL CHARACTERISTICS

Part Number	Standard Values - Case Size 0603 (1.6 x 0.8 mm)							
	Port Impedance		Center Frequency (MHz)	Insertion Loss.	Balance Port VSWR	Amplitude Difference (dB)	Phase Difference (Deg.)	Power Capacity (mW)
	Unbalanced	Balanced						
NGB0603CG2R450G050TRF	50Ω	50Ω	2450 ± 100	1.2 Max. at 25°C	2.0 Max.	2.0 Max.	180° ± 10°	500mW
				1.3 Max. at -40 to +85°C				
NGB0603CG2R450G100TRF	50Ω	100Ω	2450 ± 100	1.2 Max. at 25°C	2.0 Max.	1.5 Max.	180° ± 10°	500mW
				1.3 Max. at -40 to +85°C				
NGB0603CG2R500G100TRF	50Ω	100Ω	2500 ± 200	1.2 Max. at 25°C	2.0 Max.	1.5 Max.	180° ± 10°	500mW
				1.3 Max. at -40 to +85°C				
NGB0603CG5R400G100TRF	50Ω	100Ω	5400 ± 500	1.2 Max. at 25°C	2.0 Max.	2.0 Max.	180° ± 10°	500mW
				1.3 Max. at -40 to +85°C				

(Customization Available. Please contact NIC for any center frequency and chipset matching requirements)

NGB0805C ELECTRICAL CHARACTERISTICS

Part Number	Standard Values - Case Size 0805 (2.0 x 1.2 mm)							
	Port Impedance		Center Frequency (MHz)	Insertion Loss.	Balance Port VSWR	Amplitude Difference (dB)	Phase Difference (Deg.)	Power Capacity (mW)
	Unbalanced	Balanced						
NGB0805CG2R400G050TRF	50Ω	50Ω	2400 ± 100	0.8 Max. at 25°C	2.0 Max.	2.0 Max.	180° ± 10°	500mW
				0.9 Max. at -40 to +85°C				
NGB0805CG2R400G100TRF	50Ω	100Ω	2400 ± 100	0.9 Max. at 25°C	2.0 Max.	2.0 Max.	180° ± 10°	500mW
				1.0 Max. at -40 to +85°C				

(Customization Available. Please contact NIC for any center frequency and chipset matching requirements)

Case Size	CARRIER TAPING DIMENSIONS (mm) AND REEL QUANTITY									
	Tape	Ao	Bo	Po	So	Co	Ko	t	W	Qty
NCB0402C	Paper	1.42	2.25	4.0 ± 0.1	2.0 ± 0.05	3.5 ± 0.1	1.45 max.	0.27 max.	8.0 ± 0.3	4,000
NGB0603C	Paper	1.00	1.80				0.75 max.			4,000
NGB0805C	Embossed	1.42	2.25				1.14 max.			4,000

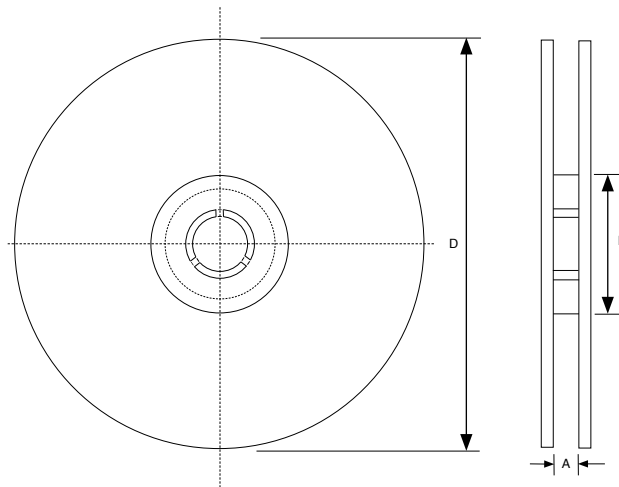
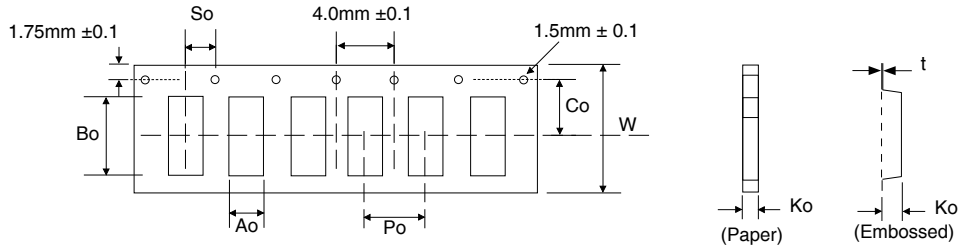

Tape Width	REEL DIMENSIONS (mm)		
	A(mm)	B(mm)	D(mm)
NGB0402C	9.0 ± 1.5	58 ± 2.0	178 ± 2.0
NGB0603C			
NGB0805C			

REFLOW SOLDERING PROFILE

