

FEATURES

- SHIELDED POWER INDUCTOR
- AUTOMATIC ASSEMBLY
- ROBUST CONSTRUCTION
- HIGH EFFICIENCY
- HIGHER CURRENT RATINGS COMPARED TO NPIS_Lx
- ULTRA LOW PROFILE (1.0 ~ 1.2mm MAX. HEIGHTS)
- SURFACE MOUNTABLE CONSTRUCTION
- TAPED AND REELED FOR AUTOMATIC INSERTION

RoHS
Compliant
includes all homogeneous materials

*See Part Number System for Details

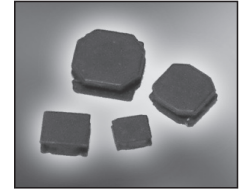

CHARACTERISTICS

Case Size	NPIM26L	NPIM20L	NPIM21L	NPIM31L
Inductance Range	0.24 ~ 10μH	0.24 ~ 33μH	0.24 ~ 10μH	0.47 ~ 10μH
Case Size	NPIM32L	NPIM40L	NPIM41L	
Inductance Range	0.33 ~ 10μH	0.33 ~ 10μH	0.33 ~ 10μH	
Ambient Operating Temperature Range	-40°C ~ +125°C (including self-heating)			
Temperature Rise at Irms	Maximum +40°C Temperature Rise			
Inductance Change at Isat	Maximum -30% Inductance Drop From Initial Measured Value			
Inductance Tolerance	±20% (M)			
Resistance to Solder Heat	+260°C for 10 seconds			

DIMENSIONS (mm)

Series	Component Dimensions				Land Pattern Dimensions				
	A	B	C	E	F	G	g'	H	I
NPIM26L	2.0 ± 0.3	1.6 ± 0.3	1.0 Max	0.6 ± 0.2	0.6	2.3	/	1.7	/
NPIM20L	2.5 ± 0.3	2.0 ± 0.3	1.0 Max	0.85 ± 0.2	0.8	2.6	/	2.1	/
NPIM21L	2.5 ± 0.3	2.0 ± 0.3	1.2 Max	0.85 ± 0.2	0.8	2.6	/	2.1	/
NPIM31L	3.0 ± 0.2	3.0 ± 0.2	1.0 Max	0.9 ± 0.2	/	/	3.0	2.7	0.8
NPIM32L	3.0 ± 0.2	3.0 ± 0.2	1.2 Max	0.9 ± 0.2	/	/	3.0	2.7	0.8
NPIM40L	4.0 ± 0.2	4.0 ± 0.2	1.0 Max	1.1 ± 0.2	/	/	4.0	3.7	1.2
NPIM41L	4.0 ± 0.2	4.0 ± 0.2	1.2 Max	1.1 ± 0.2	/	/	4.0	3.7	1.2

NPIM26L, NPIM20L
NPIM21L

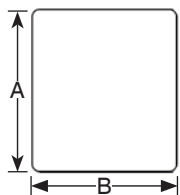

NPIM31L, NPIM32L
NPIM40L, NPIM41L

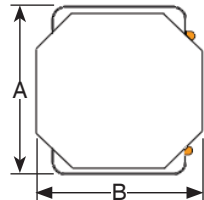

All Sizes



PART NUMBER SYSTEM

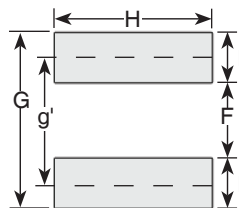
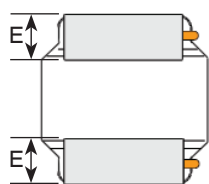
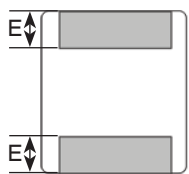
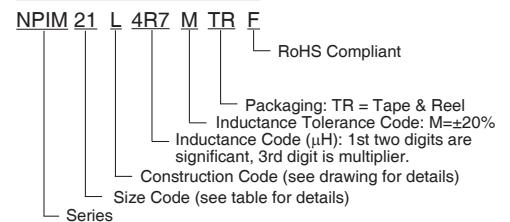

REFLOW SOLDERING
LAND PATTERN (ALL SIZES)



NPIM26L Size

Series	Standard Values - Case Size 26 (2.0x1.6x1.0mm)							
	Inductance (μH)	Test Conditions	DCR (Ω)		Isat (Amps)		IDC (Amps)	
			Max.	Typ.	Max.	Typ.	Max.	Typ.
NPIM26LR24MTRF	0.24 \pm 20%	1MHz, 1V	0.034	0.028	5.6	6.6	4	4.5
NPIM26LR33MTRF	0.33 \pm 20%		0.04	0.033	4.8	5.7	3.5	3.8
NPIM26LR47MTRF	0.47 \pm 20%		0.048	0.04	3.6	4.3	3.4	3.6
NPIM26LR68MTRF	0.68 \pm 20%		0.056	0.047	3	3.6	2.6	2.85
NPIM26L1R0MTRF	1.0 \pm 20%		0.075	0.063	2.4	3	2.5	2.7
NPIM26L1R5MTRF	1.5 \pm 20%		0.12	0.1	1.8	2.15	2.15	2.25
NPIM26L2R2MTRF	2.2 \pm 20%		0.16	0.135	1.55	1.85	1.6	1.75
NPIM26L3R3MTRF	3.3 \pm 20%		0.23	0.193	1.25	1.5	1.5	1.7
NPIM26L4R7MTRF	4.7 \pm 20%		0.34	0.28	1	1.2	1.25	1.3
NPIM26L6R8MTRF	6.8 \pm 20%		0.54	0.45	0.84	1	0.97	1.02
NPIM26L100MTRF	10 \pm 20%	0.685	0.57	0.75	0.9	0.9	0.95	

Maximum +40°C temperature rise at IDC. Maximum -30% inductance drop from initial measured value at Isat.

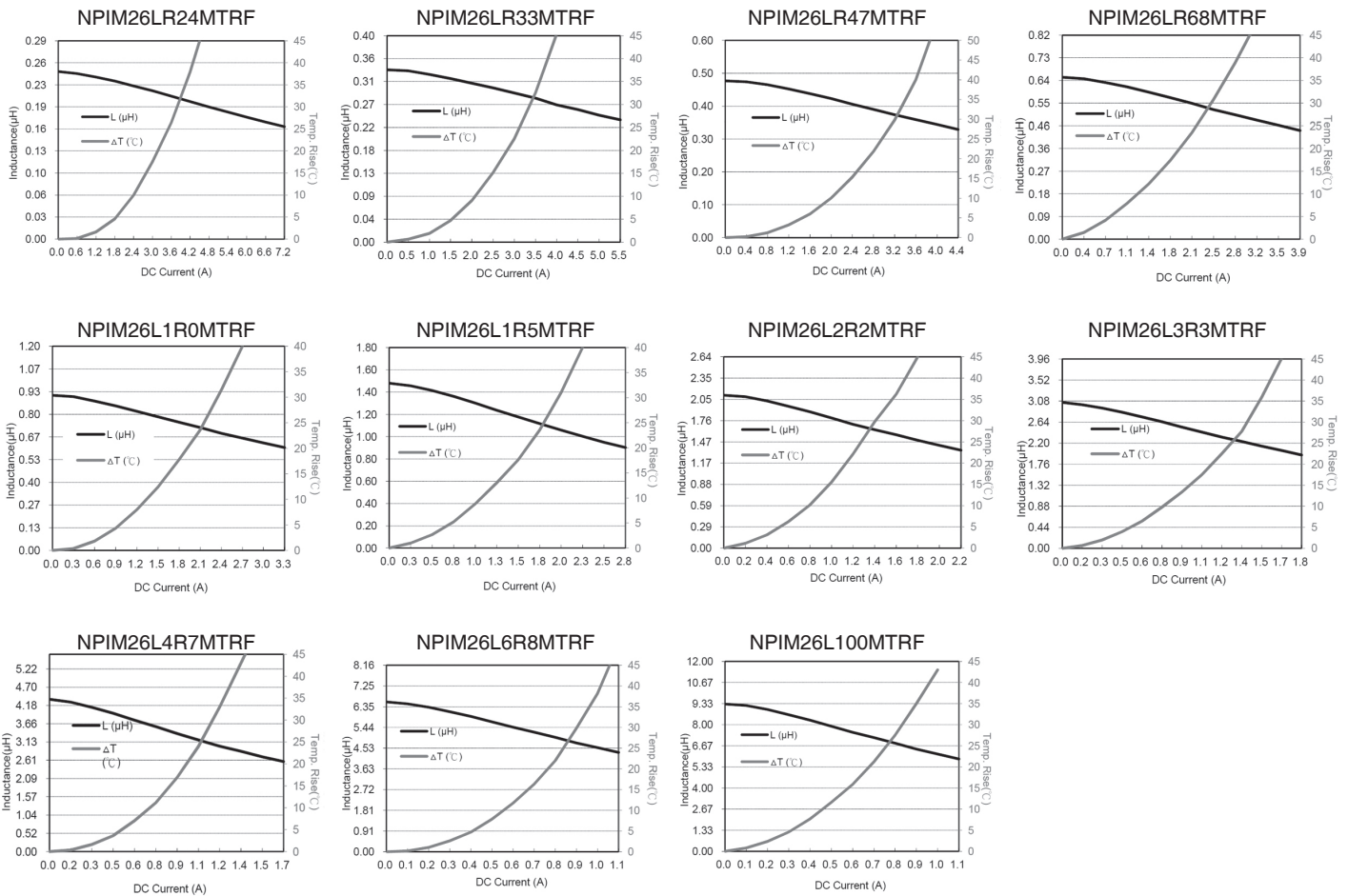

NPIM20L Size

Series	Standard Values - Case Size 20 (2.5x2.0x1.0mm)							
	Inductance (μH)	Test Conditions	DCR (Ω)		Isat (Amps)		IDC (Amps)	
			Max.	Typ.	Max.	Typ.	Max.	Typ.
NPIM20LR24MTRF	0.24 \pm 20%	1MHz, 1V	0.031	0.0265	6.8	8.1	4.1	4.3
NPIM20LR33MTRF	0.33 \pm 20%		0.036	0.03	6.1	7.3	3.6	4.1
NPIM20LR47MTRF	0.47 \pm 20%		0.0445	0.037	5.5	6.6	3.1	3.6
NPIM20LR68MTRF	0.68 \pm 20%		0.062	0.052	4.05	4.4	2.7	3.1
NPIM20L1R0MTRF	1.0 \pm 20%		0.08	0.067	3.35	4.1	2.55	2.95
NPIM20L1R5MTRF	1.5 \pm 20%		0.106	0.088	2.85	3.45	1.95	2.25
NPIM20L2R2MTRF	2.2 \pm 20%		0.15	0.124	2.6	3.2	1.55	1.85
NPIM20L3R3MTRF	3.3 \pm 20%		0.222	0.185	2.1	2.5	1.25	1.45
NPIM20L4R7MTRF	4.7 \pm 20%		0.29	0.24	1.75	2.15	1.1	1.3
NPIM20L6R8MTRF	6.8 \pm 20%		0.435	0.36	1.4	1.7	0.96	1.15
NPIM20L100MTRF	10 \pm 20%	0.53	0.44	1.28	1.55	0.85	0.96	

Maximum +40°C temperature rise at IDC. Maximum -30% inductance drop from initial measured value at Isat.

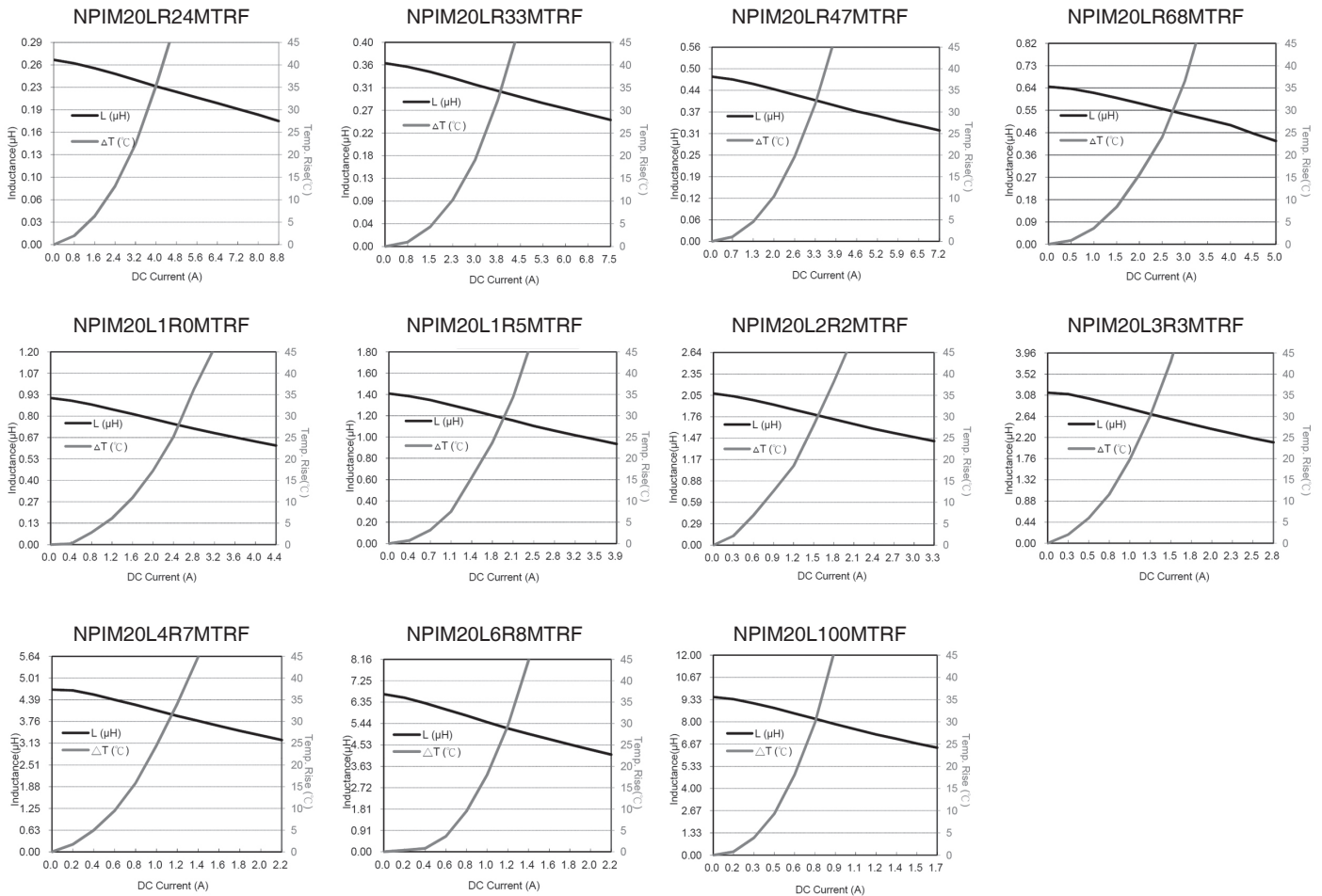

NPIM21L Size

Series	Standard Values - Case Size 21 (2.5x2.0x1.2mm)							
	Inductance (μH)	Test Conditions	DCR (Ω)		Isat (Amps)		IDC (Amps)	
			Max.	Typ.	Max.	Typ.	Max.	Typ.
NPIM21LR24MTRF	0.24 ± 20%	1MHz, 1V	0.0222	0.0185	5.9	7.1	4.4	4.8
NPIM21LR33MTRF	0.33 ± 20%		0.03	0.025	5.8	7	4.3	4.7
NPIM21LR47MTRF	0.47 ± 20%		0.0345	0.0285	4.6	5.5	4.2	4.6
NPIM21LR68MTRF	0.68 ± 20%		0.0402	0.0335	3.3	4	3.4	3.9
NPIM21L1R0MTRF	1.0 ± 20%		0.0555	0.0465	3	3.7	3.2	3.5
NPIM21L1R2MTRF	1.2 ± 20%		0.0685	0.057	2.95	3.55	3.15	3.4
NPIM21L1R5MTRF	1.5 ± 20%		0.08	0.0665	2.4	2.9	2.8	3
NPIM21L2R2MTRF	2.2 ± 20%		0.111	0.093	2.1	2.5	2.3	2.6
NPIM21L3R3MTRF	3.3 ± 20%		0.154	0.128	1.6	1.9	2	2.2
NPIM21L4R7MTRF	4.7 ± 20%		0.23	0.19	1.3	1.6	1.7	1.85
NPIM21L6R8MTRF	6.8 ± 20%		0.265	0.22	1.1	1.35	1.5	1.6
NPIM21L100MTRF	10 ± 20%		0.415	0.345	1	1.2	1.2	1.3

Maximum +40°C temperature rise at IDC. Maximum -30% inductance drop from initial measured value at Isat.

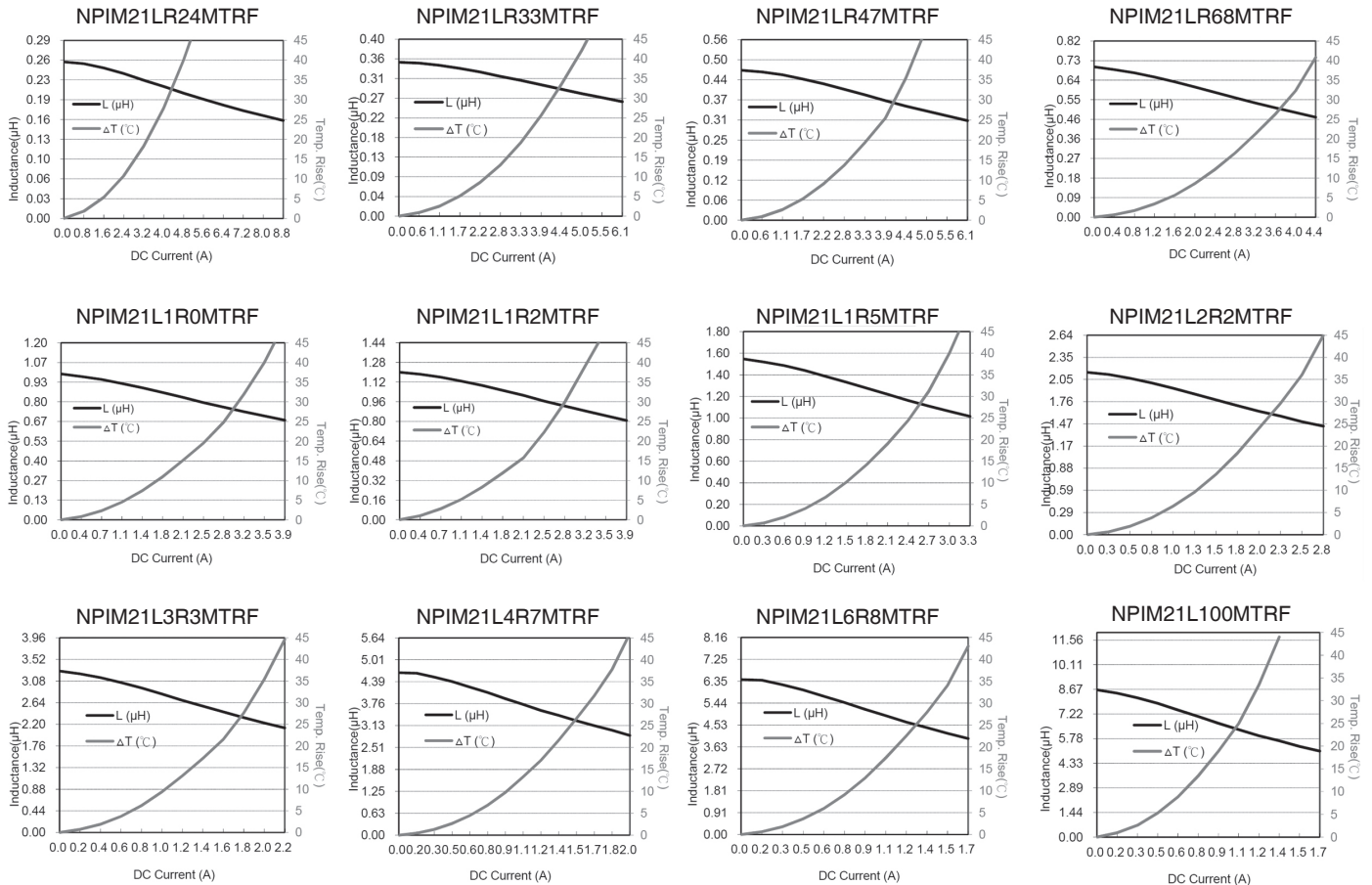

NPIM31L Size

Series	Standard Values - Case Size 31 (3.0x3.0x1.0mm)							
	Inductance (μH)	Test Conditions	DCR (Ω)		Isat (Amps)		IDC (Amps)	
			Max.	Typ.	Max.	Typ.	Max.	Typ.
NPIM31LR47MTRF	0.47 ± 20%	1MHz, 1V	0.038	0.031	5.7	6.7	3.6	4.1
NPIM31LR68MTRF	0.68 ± 20%		0.053	0.044	4.8	5.7	3.4	3.9
NPIM31L1R0MTRF	1.0 ± 20%		0.068	0.057	4.5	5.2	2.7	3.1
NPIM31L1R5MTRF	1.5 ± 20%		0.091	0.076	3.9	4.5	2.6	2.9
NPIM31L2R2MTRF	2.2 ± 20%		0.115	0.096	3.4	3.9	2.2	2.5
NPIM31L3R3MTRF	3.3 ± 20%		0.175	0.145	2.7	3.2	1.7	1.9
NPIM31L4R7MTRF	4.7 ± 20%		0.265	0.22	2.1	2.4	1.3	1.5
NPIM31L6R8MTRF	6.8 ± 20%		0.384	0.32	1.8	2.1	1.15	1.35
NPIM31L100MTRF	10 ± 20%		0.54	0.45	1.3	1.6	0.95	1.1

Maximum +40°C temperature rise at IDC. Maximum -30% inductance drop from initial measured value at Isat.

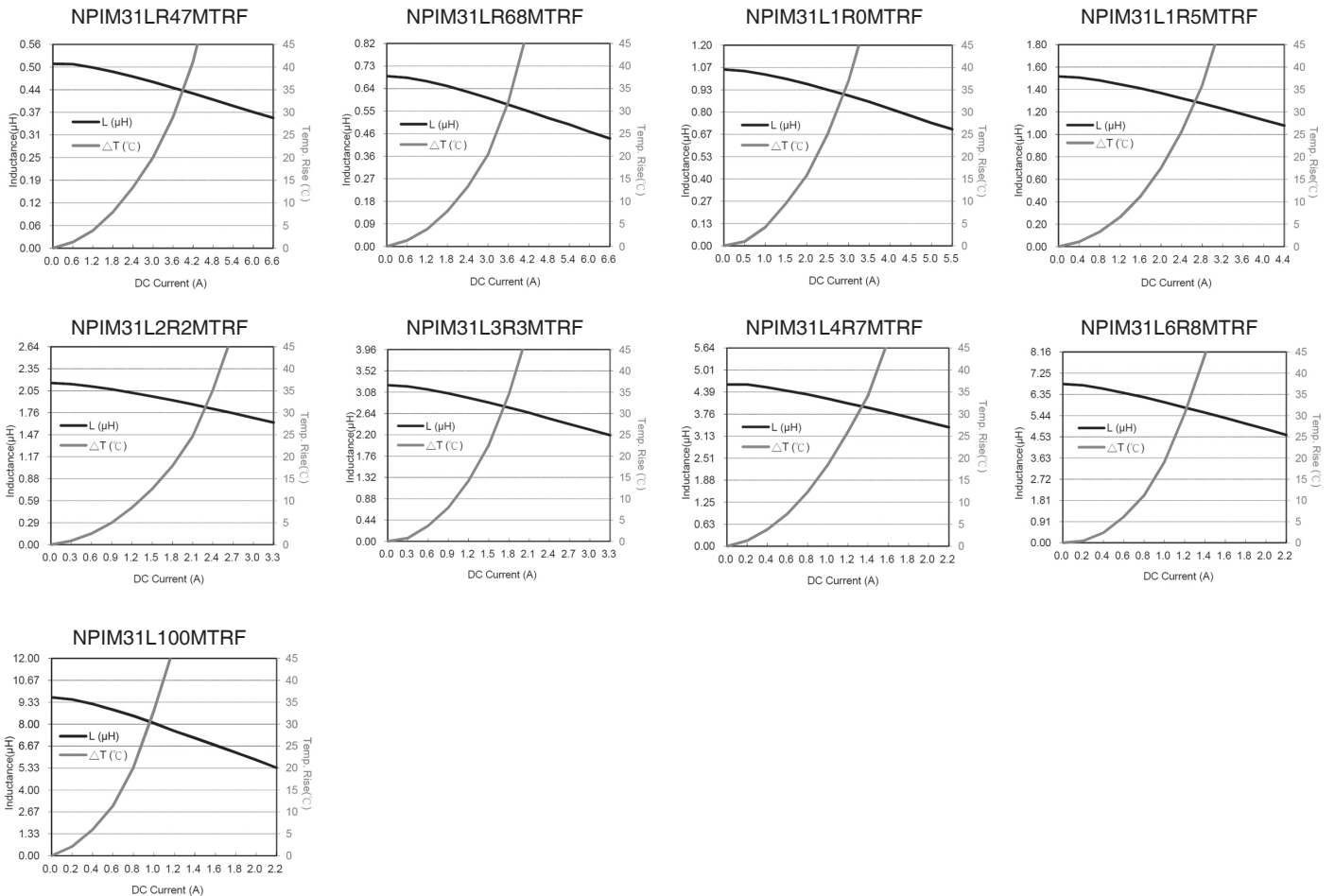

NPIM32L Size

Series	Standard Values - Case Size 32 (3.0x3.0x1.2mm)							
	Inductance (μH)	Test Conditions	DCR (Ω)		Isat (Amps)		IDC (Amps)	
			Max.	Typ.	Max.	Typ.	Max.	Typ.
NPIM32LR33MTRF	0.33 ± 20%	1MHz, 1V	0.022	0.018	7.3	8.6	4.8	6.4
NPIM32LR47MTRF	0.47 ± 20%		0.0255	0.021	6.4	7.5	4.2	5
NPIM32L1R0MTRF	1.0 ± 20%		0.0495	0.041	4.9	5.7	3.2	3.9
NPIM32L1R5MTRF	1.5 ± 20%		0.074	0.063	4.5	5.1	2.6	3
NPIM32L2R2MTRF	2.2 ± 20%		0.11	0.091	3.5	4.1	2.2	2.4
NPIM32L3R3MTRF	3.3 ± 20%		0.15	0.125	2.6	3	1.8	2.1
NPIM32L4R7MTRF	4.7 ± 20%		0.205	0.17	2.1	2.5	1.35	1.55
NPIM32L6R8MTRF	6.8 ± 20%		0.29	0.24	1.85	2.2	1.1	1.3
NPIM32L100MTRF	10 ± 20%		0.345	0.29	1.45	1.7	1.05	1.25

Maximum +40°C temperature rise at IDC. Maximum -30% inductance drop from initial measured value at Isat.

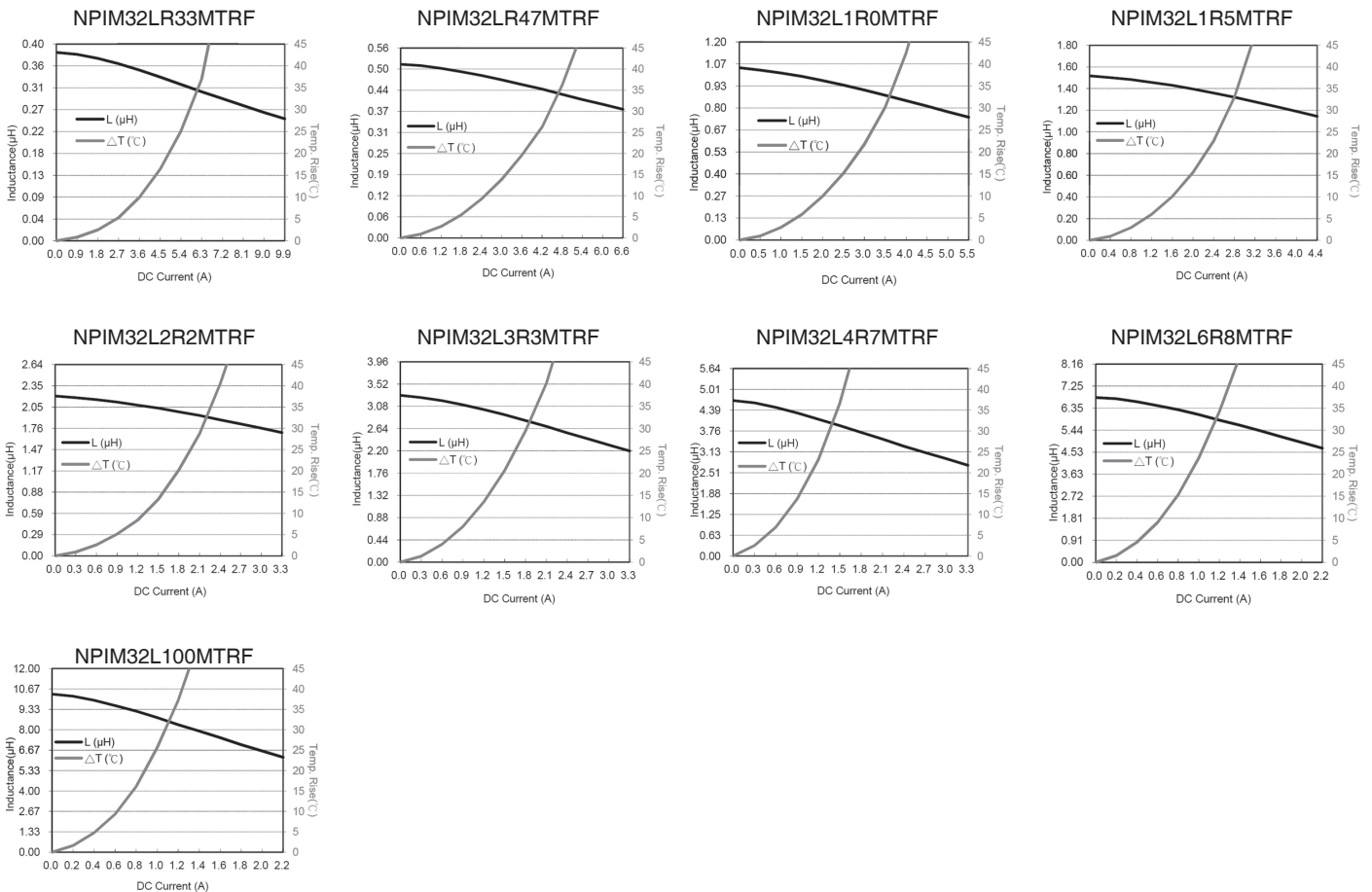

NPIM40L Size

Series	Standard Values - Case Size 40 (4.0x4.0x1.0mm)							
	Inductance (μH)	Test Conditions	DCR (Ω)		Isat (Amps)		IDC (Amps)	
			Max.	Typ.	Max.	Typ.	Max.	Typ.
NPIM40LR33MTRF	0.33 ± 20%	1MHz, 1V	0.019	0.0155	7.4	8.7	5	5.8
NPIM40LR47MTRF	0.47 ± 20%		0.024	0.02	6.4	7.9	4.7	5.5
NPIM40LR68MTRF	0.68 ± 20%		0.034	0.028	5.3	6.3	3.4	3.9
NPIM40L1R0MTRF	1.0 ± 20%		0.054	0.045	4.7	5.7	3	3.5
NPIM40L1R5MTRF	1.5 ± 20%		0.0745	0.062	3.55	4.2	2.7	3.1
NPIM40L2R2MTRF	2.2 ± 20%		0.108	0.09	3	3.6	2.4	2.7
NPIM40L3R3MTRF	3.3 ± 20%		0.174	0.145	2.4	2.8	1.8	2
NPIM40L4R7MTRF	4.7 ± 20%		0.205	0.175	2.05	2.45	1.6	1.9
NPIM40L6R8MTRF	6.8 ± 20%		0.28	0.23	1.7	2	1.35	1.55
NPIM40L100MTRF	10 ± 20%		0.39	0.325	1.4	1.7	1.1	1.3

Maximum +40°C temperature rise at IDC. Maximum -30% inductance drop from initial measured value at Isat.

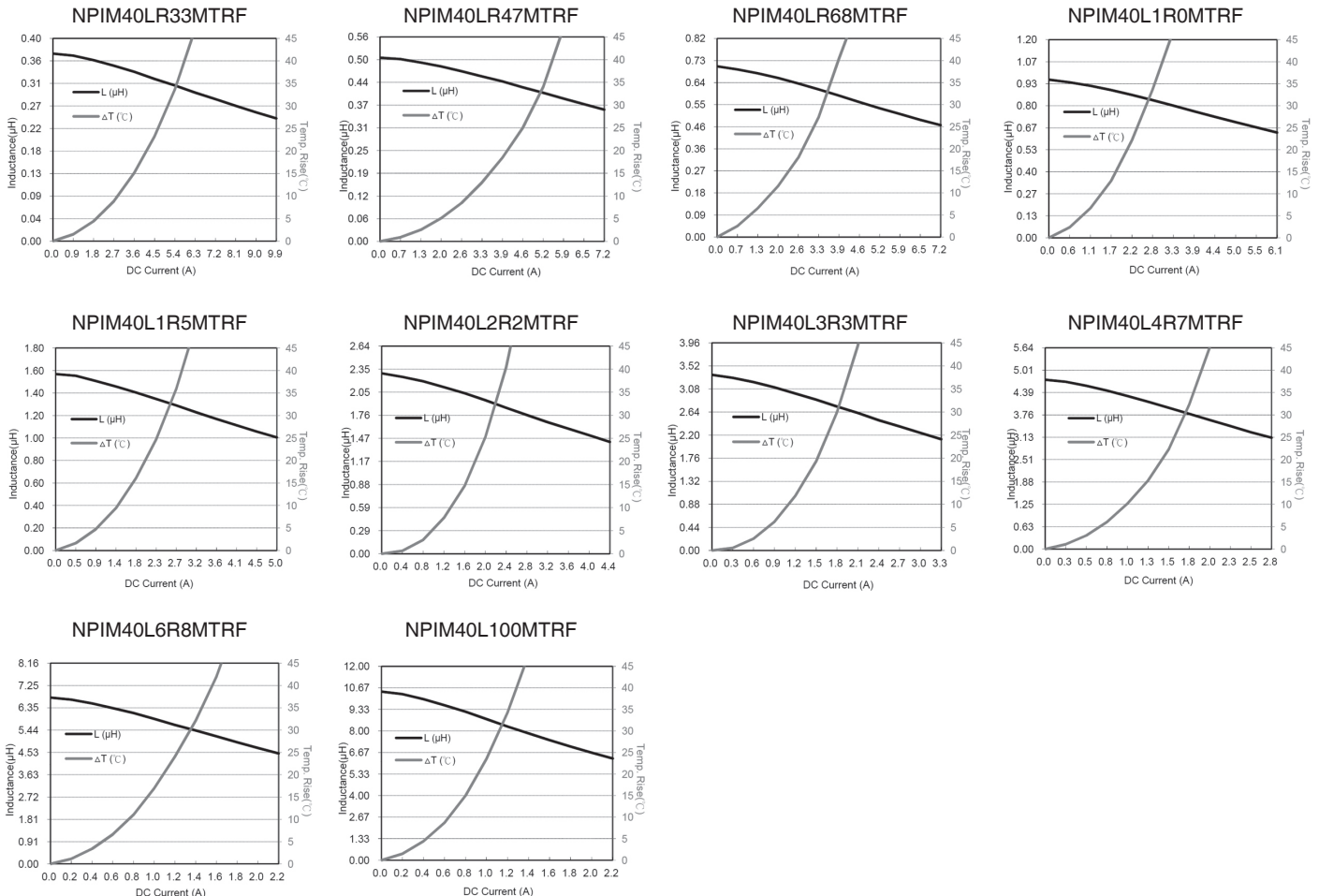

NPIM41L Size

Series	Standard Values - Case Size 41 (4.0x4.0x1.2mm)							
	Inductance (μH)	Test Conditions	DCR (Ω)		Isat (Amps)		IDC (Amps)	
			Max.	Typ.	Max.	Typ.	Max.	Typ.
NPIM41LR33MTRF	0.33 ± 20%	1MHz, 1V	0.017	0.013	9.1	10.8	6.1	7
NPIM41LR47MTRF	0.47 ± 20%		0.019	0.016	8.2	10	4.8	5.6
NPIM41LR68MTRF	0.68 ± 20%		0.026	0.022	7.1	8.2	4	4.6
NPIM41L1R0MTRF	1.0 ± 20%		0.035	0.029	5.2	6.2	3.9	4.5
NPIM41L1R5MTRF	1.5 ± 20%		0.054	0.045	4.5	5.6	3.3	3.6
NPIM41L2R2MTRF	2.2 ± 20%		0.078	0.065	3.9	4.6	2.8	3.2
NPIM41L3R3MTRF	3.3 ± 20%		0.125	0.103	3.2	4	2.25	2.6
NPIM41L4R7MTRF	4.7 ± 20%		0.145	0.125	2.55	3.1	1.95	2.25
NPIM41L6R8MTRF	6.8 ± 20%		0.22	0.19	2.1	2.5	1.65	1.85
NPIM41L100MTRF	10 ± 20%		0.3	0.25	1.7	2	1.45	1.65

Maximum +40°C temperature rise at IDC. Maximum -30% inductance drop from initial measured value at Isat.

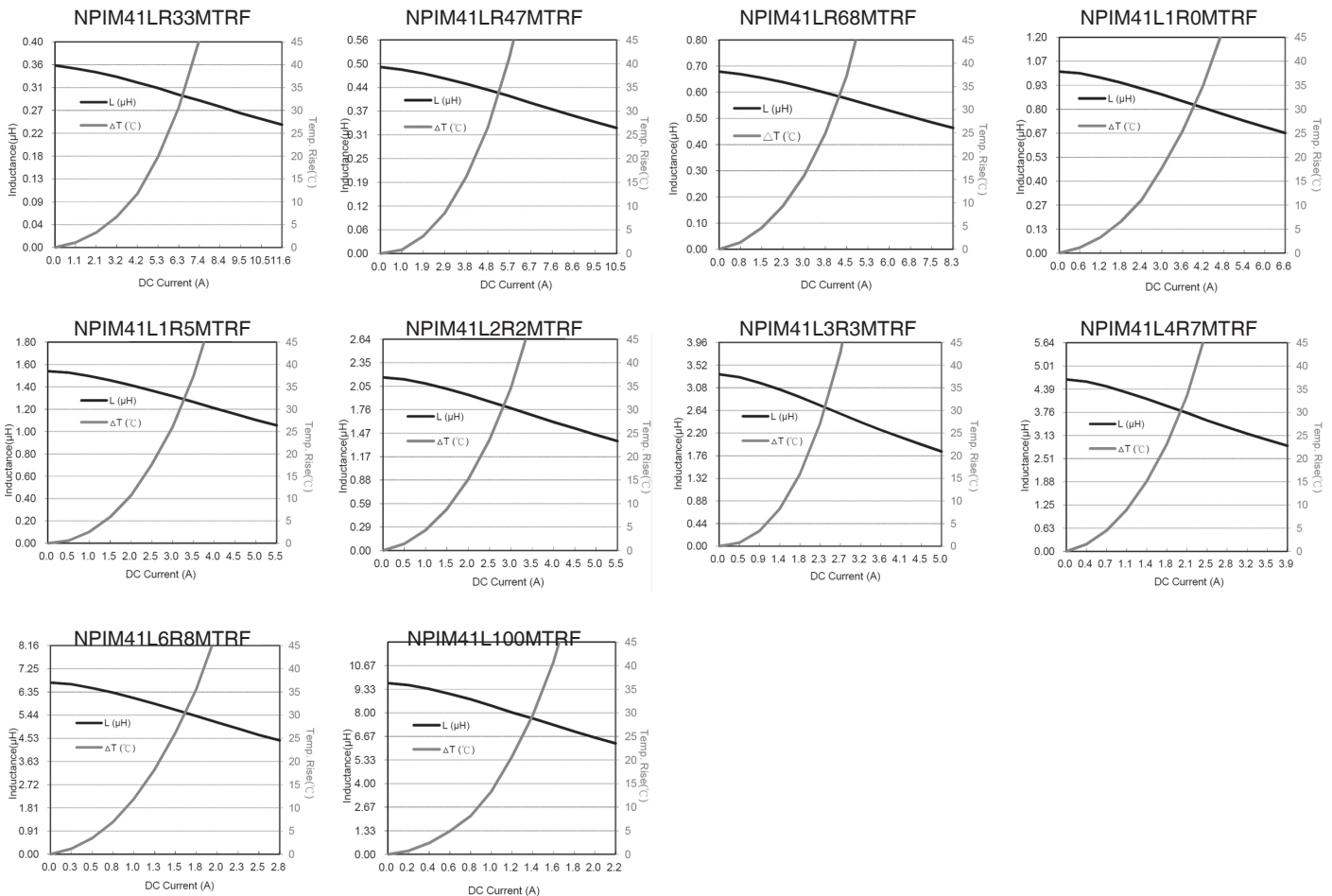

Case Size	CARRIER TAPING DIMENSIONS (mm) AND REEL QUANTITY							
	Ao	Bo	Ko	Co	W	Po	t	Quantity
NPIM26L	1.84 ± 0.1	2.25 ± 0.1	1.15 ± 0.1	3.5 ± 0.05	8.0 ± 0.1	4.0 ± 0.1	0.22 ± 0.05	3,000
NPIM20L	2.45 ± 0.1	3.1 ± 0.1	1.4 ± 0.1	3.5 ± 0.05	8.0 ± 0.1	4.0 ± 0.1	0.23 ± 0.05	3,000
NPIM21L								
NPIM31L	3.26 ± 0.1	3.4 ± 0.1	1.4 ± 0.1	3.5 ± 0.1	8.0 ± 0.3	4.0 ± 0.1	0.3 ± 0.05	2,000
NPIM32L								
NPIM40L	4.3 ± 0.1	4.3 ± 0.1	1.6 ± 0.1	5.5 ± 0.1	12.0 ± 0.3	8.0 ± 0.1	0.3 ± 0.05	1,000
NPIM41L								

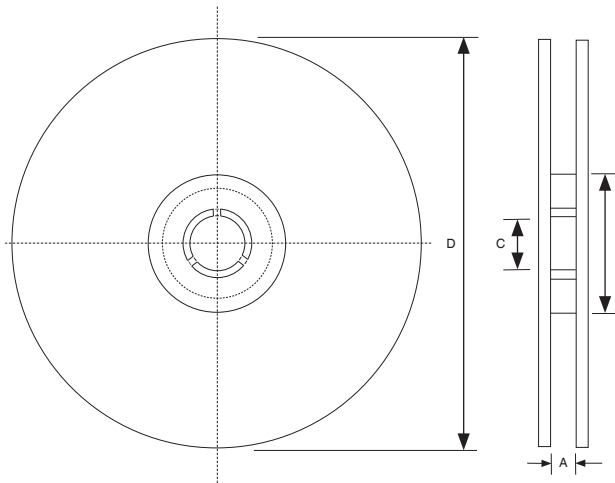
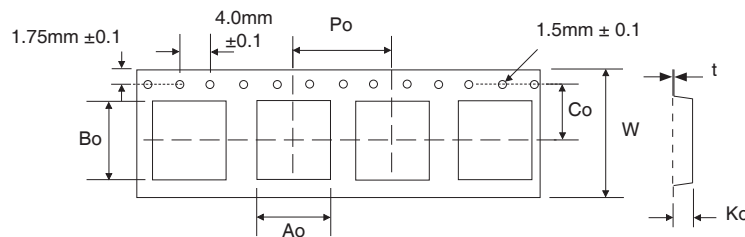

Tape Width	REEL DIMENSIONS (mm)			
	A(mm)	B(mm)	C(mm)	D(mm)
NPIM26L	8.4 +0.2/-0.1	62.0 ± 1.5	13.5 ± 0.5	180 ± 3.0
NPIM20L				
NPIM21L				
NPIM31L				
NPIM32L				
NPIM40L				
NPIM41L				

